

Warranty Statement:

All of our products sold are guaranteed to be free from defects in workmanship and materials for **one** year from date of purchase, unless otherwise stated. TPC will repair or replace any defective part at no charge. TPC will not be responsible for labor charges or shipping charges to / from the TPC facility. This guarantee does not cover normal wear or stains on surface finish. The guarantee does not cover damage resulting from improper installation, misuse or accidents incurred in shipping and handling. All claims against the freight carrier must be initiated at the time the damaged items are received. The claim is the responsibility of the customer. We are improving our products on a continuous basis. We reserve the right to make modifications without the need for prior notification and are not obliged to modify previously manufactured items. Bulbs and batteries are not covered under any type of warranty.

TPC *Advanced Technology, Inc.*

851 S. Lawson St
City of Industry CA 91748

TPC *Advanced Technology, Inc.*

PC2630 / PC2930 User Manual



Table of contents.

1. Cover Page
2. Table Of Contents + Markings
3. Initial Setup
4. Operation of controls
5. Operation of controls
6. Operation of controls
7. General use instructions
8. General Service after use
9. Replacement components
10. Working principal diagram
11. Troubleshooting
12. Back Page Warranty Statement

Markings

Notice: Risk of losing accessories and documents

Caution: Risk of injury or malfunction

Read carefully of the manual.

Ground Protective

Electron garbage bin

Producing date

On

Off

Figures



Troubleshooting

Unit will not power on:

Check power cord.
 Check power switch.
 Check resettable fuse.
 If no green light is illuminated then there is no power to the main switch.
 Check fuse. Check outlet.

Suction is Low:

Verify the Saliva Ejector Valve lever is opened.
 Verify there are no kinks in the tubing.
 Verify waste container is secured.
 Check saliva Ejector screen located under the rubber tip.
 Air Venture Valve clogged. Contact support for further instructions.

Low handpiece pressure:

Try adjusting the HP pressure using the adjustments in operation of controls.
 If adjustment knobs do not adjust the pressure, check both HP positions. If the result is the same on both positions the main regulator may need adjusting. Call support for further instructions.

Unit is very loud when the motor is running.

Verify shipping screw have been removed.

Unit make a pop sound when the compressor is running:

If you hear a consistent pop sound while motor is running, discontinue use immediately. The safety pressure valve is active. This Valve releases excessive pressure in the event the automatic pressure shut off fails. Contact TPC support for further instructions.

Replacement Components

700ML Water Bottle
 (Cap Not Included)



PartNumber:
 PC-2630N-CWB
 Saliva Ejector Valve



Part Number: P2340

3-Way Syringe Press
 Style



Part Number:
 TPC3WAY-PR
 Replacement Piezo HP



Part Number: A745

Waste Bottle
 container:

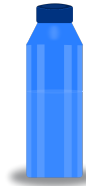

Part Number:
 PC2630-SWC-N

Saliva Ejector Tip 5pk



Part Number: P2185

3-Way Syringe
 Replacement Tips: 5Pk



PN: M7500-5

Piezo Scaler tips 5 PK



G1 G2 G4 P3 P5

Part Number: A789

Optional
 Stainless Steel Tray
 Door Mounted

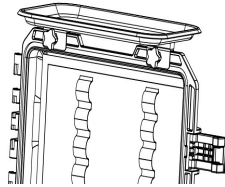

Part Number:

Saliva Ejector Spool



Part Number: P2169

LED 39 Replacement
 Light guide



Part Number: P109-LG

Suction tips



Part Number :

Note! You must remove the two shipping bolts located on the bottom of unit. Failure to remove will result in excessive vibration. Replace when transporting unit.

Remove two shipping bolts located on bottom of unit prior to use. Failure to remove will result in excessive vibration. An Allen wrench has been included with your package for removal. Do not discard the bolts and wrench.

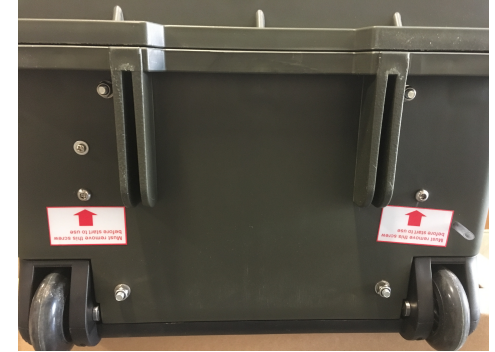

Connect power cable to inlet power port on the display of the unit as shown.

Replacement Power Cord:
 Part Number: PC2630N-PC

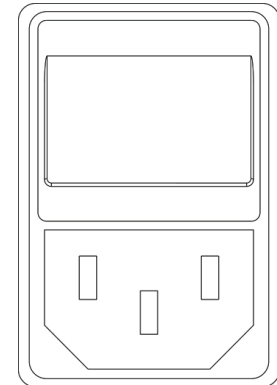

Turn the power switch to the "on" position and the unit's air compressor will cycle on.



Turn the power switch to the "off" position to discontinue use.



Allow unit to cycle to full tank capacity prior to use. It should only take 1 minute for the units reserve tank to fill completely then the air compressor motor will turn off. If motor continually runs, verify the suction valve is turned to the off position. Verify S.E. Valve is placed in the automatic holder. PC2930 version units have automatic HP control switches inside holders that activate each position.

Operation of controls

HP Pressure Adjustment:

Turn clockwise to decrease pressure. Counter clockwise to increase pressure.

Air Coolant Adjustment:

Air coolant is controlled by the main drive air adjustment.

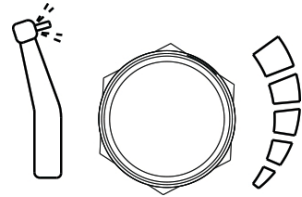

HP Selector Switch: PC2630

Use this switch to select the desired HP position. Both HP positions have the ability to operate as a Hi or Slow speed position.

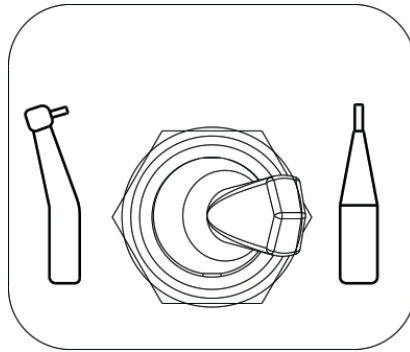

HP Selector Switch: PC2930

The PC2930 portable unit uses an automatic HP selector switch for each HP, Se valve and Scaler activation. Remove the desired HP from the holder and it will be activated and ready to use. Only use one HP at a time.

Working Principal of unit diagram

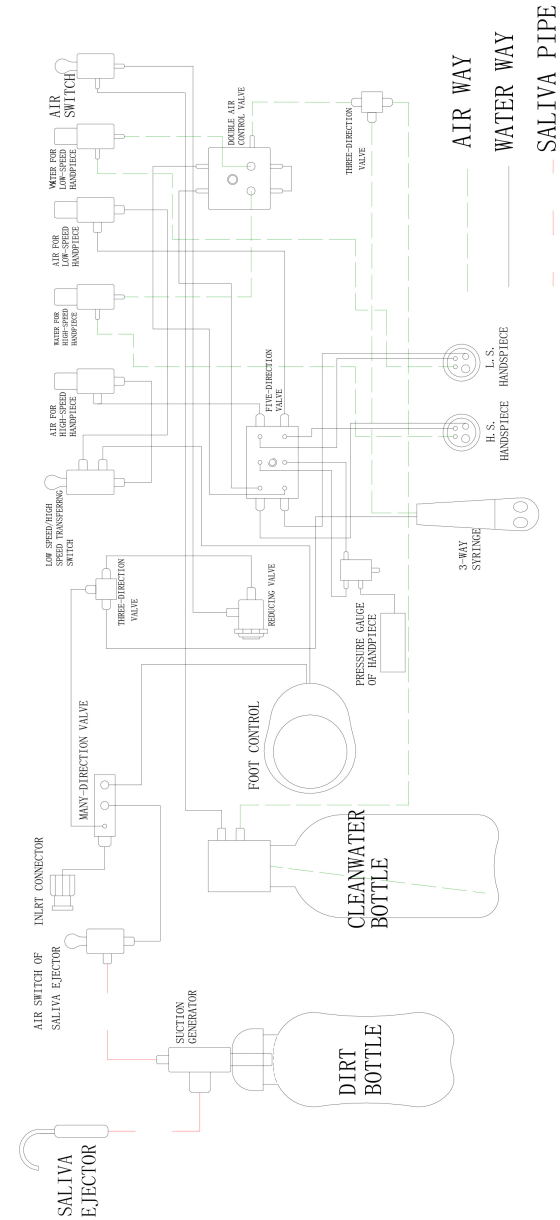

General Service after use!

Remove Waste Container:

Turn waste container counter clockwise to remove. Clean with running water and disinfect with suitable solution. Do not autoclave the waste container!

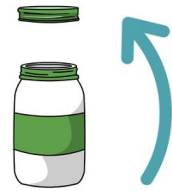

Removal of water bottle:

Turn water bottle switch to the off position: when the air purge is complete, turn the bottle counter clockwise to remove.



Wiping the unit:

Don't spray any chemicals directly on the face of the dental unit. To clean, spray a cloth and wipe clean. Take caution when cleaning around the electrical outlet.



Flushing the Vacuum system:

To flush the Vacuum system, allow the unit to reach its full tank capacity. Once full, submerge the Saliva Ejector Valve in two cups of water mixed with cleaning solution. Allow the system to completely vacuum the mix through out the system. Once complete, Flush again with water.



Purge Valve: Press the drain valve button "IN" on the side of the unit. This will allow any moisture in the tank to drain.



Operation of controls

Water Bottle Switch:

Turn this switch to the "ON" position to pressurize the bottle system. Turn to the "OFF" position to depressurize the system.

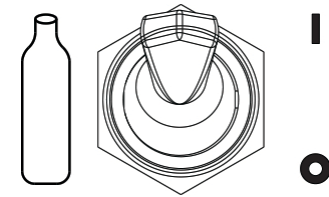

Water Flow control for HP1:

To adjust the water flow to the HP use the adjustment knob shown. Turn clockwise to decrease water supply. Counter clockwise to increase water supply.

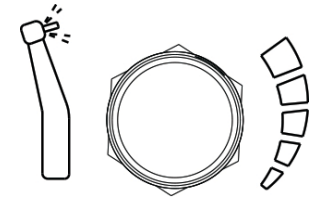

Water Flow control for HP2:

To adjust the water flow to the HP use the adjustment knob shown. Turn clockwise to decrease water supply. Counter clockwise to increase water supply.

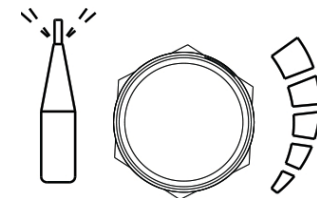

3-Way Syringe Adjustment:

Turn clockwise to decrease pressure. Counter clockwise to increase pressure.

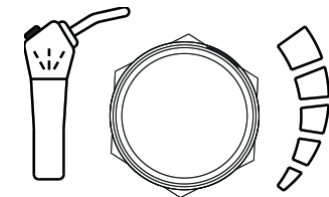

Suction On/Off:

Switch to "on" position to turn the suction system on. Turn the switch to the "off" position and suction will turn off. Turn off when removing suction waste container.

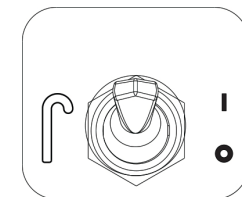

Dental Unit Foot Control:

Depress foot control to supply air pressure to dental unit hp tubing. The selected HP position will begin to expel air from the end of the tubing.

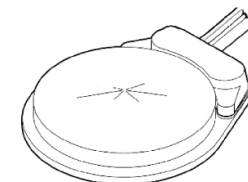

Operation of controls

Optional:

Water adjustment for optional built in scaler. Turn clockwise to decrease water flow. Turn counter clockwise to increase water flow.

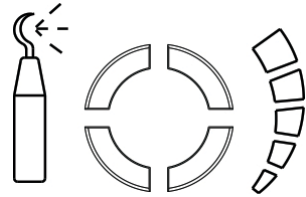

Optional:

Frequency adjustment knob for built in scaler. Turn Clockwise to increase frequency. Turn counter clockwise to decrease frequency.

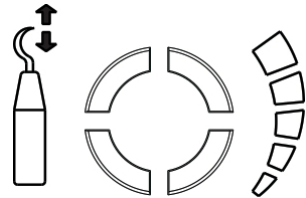

General use Instructions

- Turn power on master switch to “ON” position.
- Attach desired HP to HP tubing.
- Press the unit foot control to supply air pressure at the HP.
- Using the handpiece pressure adjustment set the required HP pressure to the HP.
- Adjust the water flow out of the HP using the water control knob.
- If water is not creating a spray, adjust the AIR COOLENT adjustment screw. Once adjusted properly the water should create a mist.
- To use the Saliva Ejector Valve, lift se valve from holder, the suction will activate automatically. If the waste container becomes full a decrease in suction may occur. Empty waste container to retain your suction levels.
- Turn the suction Valve off prior to removing waste bottle. Place se valve back in holder to turn off the suction. The PC2930 portable unit uses an automatic HP selector switch for each HP, Se valve and Scaler activation. Remove the desired HP from the holder and it will be activated and ready to use. Only use one HP at a time. Place back in holder to deactivate position.

General use Instructions Scaling

Attaching the scaling tip:

The tip must be screwed and moderately tightened by means of the corresponding wrench. If tip is not secure, vibration to the tip may be decreased.

The tip must be screwed and moderately tightened by means of the corresponding wrench. If tip is not secure, vibration to the tip may be decreased.

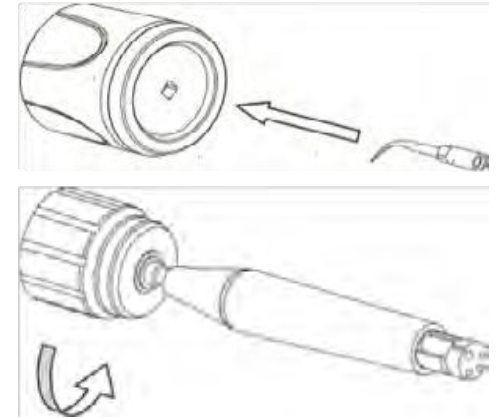

***To remove sclaeer handpiece from tubing, Gently pull straight off. Don't turn / twist or damage to tubing pins will occur.**

General use Instructions Curing

Insert light guide tip into light.

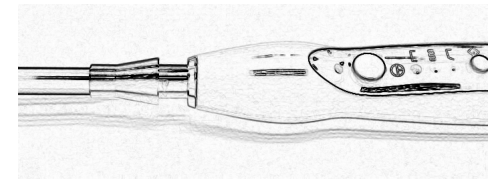

Place Blue light shield over light guide. Secure in place over the metal chuck.

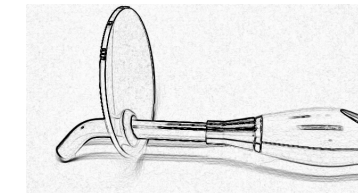

Press the “ON” button to wake the light from sleep mode. Press again to activate light.

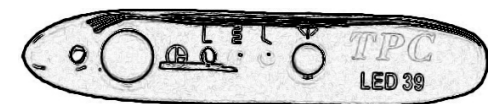

Cure Modes:

Fast:

Pulse:

Ramp:

☐ Full power output

⏏ 0.5 second intermittent output

⏏ Soft start

A800N Maintenance and Sterilization

Tip Sterilization

Maintenance:

Cleanings/Disinfecting: If necessary, prior to sterilization, rinse tips under water to remove any gross debris. The use of cleaning and disinfectant solutions, such as ultrasonic cleaning solutions, is not recommended. Sterilization: •Place tip in a paper or paper/plastic steam sterilization pouch. Place the paper side up when using a paper/plastic steam sterilization pouch. •Place the bagged tip into the steam autoclave. After warm-up is completed, operate at a sterilizing temperature and pressure of 273° F/31 psi (134°C/216 kPa) for 12 minutes, followed by a 20-30 minute drying time. •To maintain sterility, the insert should remain in the sealed pouch until it is ready for use.

The outer surfaces of the TPC A850 Ultrasonic Scaler, consisting of the cabinet, water bottle, control knobs, power line cord, handpiece, handpiece cable assembly, footswitch and footswitch cable, should be cleaned and disinfected. The detachable handpiece and ultrasonic tips require cleaning and sterilization. Preferred methods are discussed. However, alternatives are available. Special steps may be required when following an alternate method.

Beginning Of The Day

Recommended Daily Procedures

Fill the on board water bottle with purified water or a medicament solution of your choice; or connect the water line to water supply source and select water source with the <Water> button. Connect a sterilized handpiece to its mating handpiece cable assembly. Hold the handpiece over a sink or drain, set power to low, activate the foot control, and flush the water line of the unit at maximum water flow for at least 2 minutes. Place a freshly sterilized tip into the handpiece. The unit is now ready for operation.

Handpiece Sterilization

Between Patients

Cleaning: •Wipe handpiece with a cloth saturated with multi-purpose instrument cleaner/disinfectant. •Discard cloth. •Rinse entire handpiece with water. •Dry handpiece thoroughly with a clean, lint-free cloth. •DO NOT use heat to dry handpiece.

NOT USE Cold sterilization solution. •DO NOT USE chemical disinfectant prior to sterilization or rapid deterioration of the materials may occur. •DO NOT sterilize handpiece cable

Sterilizing: •Detach the handpiece from its connection cord and remove the tip. •Place the handpiece into the steam autoclave. After warm-up is completed, operate at a sterilizing temperature and pressure of 273° F/31 psi (134°C/216 kPa) for 12 minutes, followed by a 20-30 minute drying time. •Remove the handpiece from the autoclave as soon as sterilization is complete. •Carefully dry the electrical contacts of the handpiece and cable connector before connecting them.

Remove all ultrasonic tips and handpiece used, clean and sterilize. Clean and disinfect the surfaces of the cabinet, Power Cord, Handpiece cable assembly*, control knobs, Foot Control and cable assembly by applying an approved non-immersion type disinfectant solution* carefully following the instructions provided by the disinfectant solution manufacturer. To clean system, generously spray disinfectant solution on a clean towel and wipe all surfaces. Discard used towel. To disinfect system, generously spray disinfectant on a clean towel and wipe all surfaces. Allow disinfectant solution to air dry. Connect a handpiece to its matching handpiece cable assembly. Hold the handpiece over a sink or drain and flush the water line of the unit as above at maximum water flow for 30 seconds. Place a freshly sterilized tip into the handpiece.

End Of The Day

Remove all ultrasonic tips and handpiece used, clean and sterilize. Clean and disinfect the surfaces of the cabinet, Power Cord, Handpiece cable assembly, Foot Control and cable assembly by applying an approved non-immersion type disinfectant solution* carefully following the instructions provided by the disinfectant solution manufacturer. To clean system, generously spray disinfectant solution on a clean towel and wipe all surfaces. Discard used towel. To disinfect system, generously spray disinfectant on a clean towel and wipe all surfaces. Allow disinfectant solution to air dry. *Note: water-based

Replacing LED Bulb

- Remove Tip
- Twist off nipple counter clockwise and remove
- Pull off LED Light Bulb Cartridge and reinsert a new bulb
- Make sure LED Light Bulb pins are align